

MPT-Support profile Q100 with 3 slots

hot-dip galvanised

Application

- For support structures used in ship-building and on industrial and plant building sites
- Additional mounting slot increases connection possibilities, for example for 3D fixtures

Your advantages

- For construction of safe structures due to the high load-bearing capacity of the profile
- Saves time and costs due to functional accessories that are matched to the support profile
- Clean-cut appearance by the use of MPT-protection caps

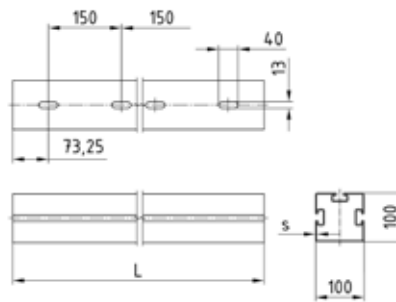

Profile	Length L [mm]	Thickness s [mm]	Weight [kg]	Part no.	Sales unit	Pack unit
Q100-2.5 3-slots	6,000	2.5	64.8	142547	1	Pieces



MPT-Support profile Q100 with 3 slots

hot-dip galvanised

Technical data of profile:

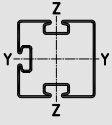
Features										
Profile	Material	Surface	Admissible steel stress σ_{adm} [N/mm ²]	Available hammer head bolts	Profile weight [kg/m]	Profile cross-section [cm ²]	Moment of inertia		Resistance moment	
							I_y [cm ⁴]	I_z [cm ⁴]	W_y [cm ³]	W_z [cm ³]
 Q100-2.5 3-slots	S235	hot-dip galvanised	158	M10, M12	10.8	13.75	187.5	171.3	37.5	32

Max. load capacities of profile [N]:

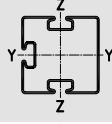
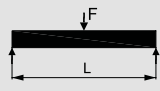
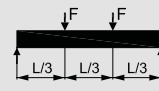
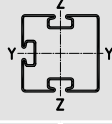
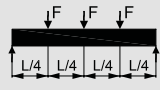
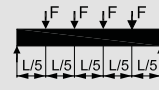
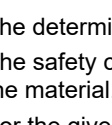
Profile	Bending into direction	L [m]						L [m]					
		0.5	1.0	1.5	2.0	4.0	6.0	0.5	1.0	1.5	2.0	4.0	6.0
 Q100-2.5 3-slots	ZZ												
	YY	37,411	22,059	15,232	11,540	5,642	2,228	25,411	15,338	10,996	8,459	3,313	1,308
 Q100-2.5 3-slots	ZZ												
	YY	33,732	19,221	13,184	9,991	5,047	2,398	23,637	13,605	9,610	7,367	3,167	1,407
 Q100-2.5 3-slots	ZZ	16,955	10,218	7,331	5,641	2,376	938	13,262	8,271	6,017	4,658	1,866	737
	YY	15,774	9,063	6,407	4,913	2,272	1,009	12,437	7,382	5,278	4,067	1,784	793

-  The determined loads apply for static loads. Calculation based on Eurocode (EC3).
 The safety coefficient $\gamma = 1.48$ takes into account the partial and combination coefficients as well as the safety factor of the material.
 For the given values, the permissible steel stress and the maximum permissible deflection $L/200$ are not exceeded, taking the deadweight into consideration.

MPT-Support profiles

Buckling loads

Permissible buckling loads for profiles [N]:

Buckling length Lk [mm]	Q50-2.5	Q80-2.0	Q100-2.5	Q100-3.5	Q100-2.5 3-slots	Q100-2.5 4-slots	Q150-2.5 3-slots
200	128,182	126,656	195,325	209,821	236,373	263,994	247,208
400	127,400	126,656	195,325	209,821	236,373	263,994	247,208
600	122,358	124,732	195,325	209,821	236,373	263,994	247,208
800	116,925	121,003	192,269	206,737	232,980	260,028	244,946
1,000	110,833	117,063	187,954	202,159	227,846	254,244	239,937
1,200	103,867	112,799	183,477	197,414	222,528	248,247	234,784
1,400	95,963	108,111	178,763	192,425	216,938	241,938	229,409
1,600	87,313	102,923	173,738	187,116	210,993	235,220	223,739
1,800	78,371	97,214	168,338	181,417	204,614	228,007	217,702
2,000	69,681	91,042	162,510	175,273	197,740	220,227	211,238
2,200	61,661	84,554	156,224	168,650	190,332	211,839	204,298
2,400	54,519	77,964	149,485	161,547	182,387	202,845	196,861
2,600	48,291	71,499	142,342	154,010	173,953	193,304	188,935
2,800	42,918	65,344	134,888	146,130	165,128	183,335	180,572
3,000	38,301	59,625	127,255	138,039	156,059	173,109	171,866
3,200	34,333	54,399	119,596	129,894	146,918	162,824	162,948
3,400	30,915	49,677	112,059	121,851	137,881	152,681	153,968
3,600	27,959	45,440	104,771	114,047	129,102	142,852	145,079
3,800	25,393	41,652	97,827	106,589	120,702	133,467	136,416
4,000	23,153	38,269	91,288	99,547	112,761	124,613	128,089
4,200	21,191	35,248	85,186	92,958	105,326	116,337	120,172
4,400	19,462	32,546	79,527	86,836	98,412	108,653	112,713
4,600	17,933	30,126	74,303	81,174	92,013	101,551	105,733
4,800	16,575	27,954	69,495	75,955	86,112	95,007	99,233
5,000	15,364	25,999	65,077	71,153	80,679	88,989	93,200
5,200	14,279	24,236	61,020	66,740	75,684	83,460	87,615
5,400	13,304	22,641	57,296	62,684	71,092	78,380	82,450
5,600	12,425	21,194	53,875	58,956	66,870	73,712	77,678
5,800	11,629	19,879	50,730	55,527	62,986	69,420	73,268
6,000	10,908	18,680	47,837	52,370	59,409	65,469	69,192
6,200	10,250	17,585	45,171	49,460	56,112	61,827	65,423
6,400	9,651	16,581	42,712	46,774	53,068	58,467	61,934
6,600	9,102	15,660	40,441	44,293	50,255	55,363	58,702
6,800	8,598	14,813	38,339	41,996	47,652	52,490	55,704
7,000	8,136	14,032	36,392	39,868	45,239	49,828	52,920
7,200	7,709	13,311	34,586	37,893	42,999	47,358	50,332
7,400	7,315	12,643	32,907	36,057	40,917	45,062	47,922
7,600	6,950	12,024	31,345	34,348	38,980	42,926	45,676
7,800	6,612	11,449	29,890	32,756	37,173	40,934	43,580
8,000	6,298	10,914	28,531	31,269	35,487	39,076	41,622
8,200	6,006	10,416	27,262	29,880	33,911	37,338	39,789
8,400	5,733	9,951	26,074	28,579	32,436	35,713	38,073
8,600	5,479	9,516	24,961	27,361	31,054	34,190	36,463
8,800	5,241	9,108	23,917	26,218	29,757	32,761	34,951
9,000	5,018	8,727	22,936	25,144	28,538	31,418	33,530
9,200	4,810	8,368	22,014	24,134	27,393	30,156	32,193
9,400	4,613	8,032	21,145	23,183	26,314	28,967	30,933
9,600	4,429	7,715	20,327	22,286	25,296	27,846	29,744
9,800	4,256	7,416	19,555	21,441	24,337	26,789	28,622
10,000	4,092	7,135	18,825	20,642	23,430	25,791	27,562
10,200	3,938	6,869	18,136	19,886	22,573	24,846	26,559
10,400	3,792	6,617	17,483	19,171	21,761	23,953	25,609
10,600	3,654	6,380	16,865	18,494	20,993	23,106	24,709
10,800	3,524	6,154	16,278	17,851	20,264	22,303	23,855
11,000	3,400	5,941	15,722	17,241	19,572	21,541	23,044
11,200	3,283	5,738	15,194	16,662	18,914	20,818	22,274
11,400	3,172	5,546	14,691	16,112	18,290	20,129	21,541
11,600	3,066	5,363	14,213	15,588	17,695	19,475	20,844
11,800	2,966	5,189	13,758	15,089	17,129	18,851	20,180
12,000	2,870	5,023	13,324	14,614	16,589	18,257	19,547



MPT-Support profiles

Buckling loads



Buckling loads as per DIN EN 1993-1-1 sections 6.2 and 6.3.

The values in the table apply for fully bearing cross-sections and central load transmission!

The potentially lower slenderness parameter for buckling and lateral torsional buckling must be examined separately!

Buckling about the z-axis and the y-axis was considered.

The least favourable buckling load is documented in the table.

The safety coefficient $\gamma = 1.54$ takes into account the safety and combination coefficients as well as the safety factor of the material.

Determine the authoritative buckling length L_k depending on the storage conditions and the rod length l , as shown in the figure.

Read off the buckling load F as L_k from the table.

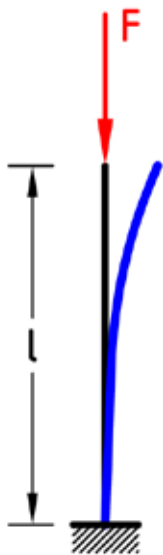

$$L_k = 2,0 \times l$$

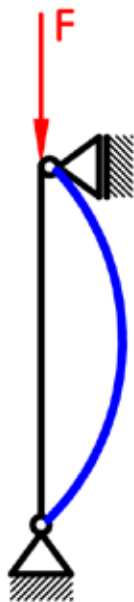

$$L_k = 1,0 \times l$$

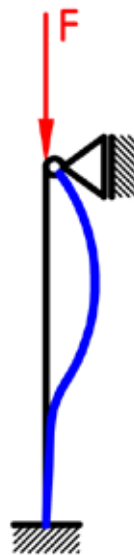

$$L_k = 0,7 \times l$$



$$L_k = 0,5 \times l$$