

MPR-Support channels

H-Profiles, sendzimir galvanised

Application

- Ideal for space-saving support of multisection pipeways between ceiling beams
- Ideal for pipe installation as support structure as well as for air ducts in dry interiors
- Variety of mounting options for pre-wall installations and shelves in combination with extensive range of system components

Your advantages

- Fast and efficient attachment of piping and pipe routes
- Ideal combination of high bending stiffness and ease of installation
- Channel slots on both sides allow simple and quick alignment of all suspended and floor-mounted pipe supports
- Scale marks sideways and on the side with the slot simplify the alignment of the attachment elements during installation and facilitate the measuring and cutting to length of the section on site
- Suitable vibration control elements for all support channels available
- Clean-cut appearance by the use of MPR-protection caps
- Meshing into the channel slot for positive-fit attachment of add-on parts

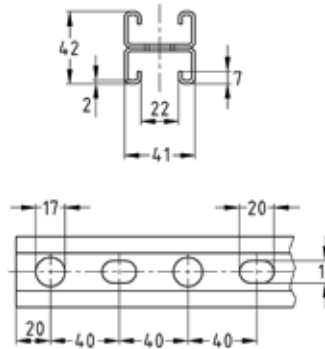

Profile 41/42/2.0

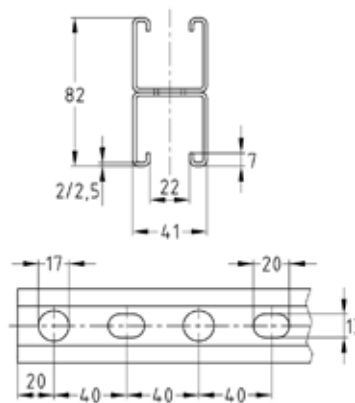

Profile 41/82/2.0, 41/82/2.5

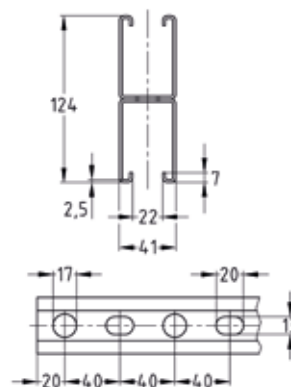

Profile 41/124/2.5

Features

Profile	Length [mm]	Part no.	Sales unit	Pack unit
41/42/2.0 H	6,640	150968	1	Pieces
41/82/2.0 H		150969		
41/82/2.5 H	6,000	177352		
41/124/2.5 H	6,640	151050		



 For use in areas with requirements on the duration of fire resistance, the boundary conditions set out in the fire test report must be observed.

MPR-Support channels

Technical data

Technical data of profile:

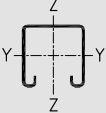

Features

Profile	Material	Surface	Admissible steel stress $\sigma_{adm.}$ [N/mm ²]	Available threaded plates*	Profile weight [kg/m]	Profile cross-section [cm ²]	Moment of inertia		Resistance moment	
							I_y [cm ⁴]	I_z [cm ⁴]	W_y [cm ³]	W_z [cm ³]
										
41/21/1.5	S250GD+Z	sendzimir galvanised	162	M6, M8, M10, M12, M16	1.08	1.3	0.767	3.521	0.695	1.718
41/21/2.0	S250GD				1.45	1.62	0.8894	4.5246	0.839	2.207
41/41/2.0	S250GD		188		2.08	2.42	4.9736	7.5692	2.451	3.692
41/41/2.5					2.53	3.08	5.8103	9.0333	2.839	4.406
41/62/2.5			3.38		3.98	17.209	12.9297	5.671	6.307	
41/42/2.0 H			2.9		3.24	5.2844	9.0492	2.516	4.414	
41/82/2.0 H			4.16		4.83	30.6876	15.1385	7.485	7.385	
41/82/2.5 H			S250GD+Z		5.05	5.87	36.3506	18.0667	8.866	8.813
41/124/2.5 H	S250GD		6.76		7.96	111.7528	25.8595	18.025	12.614	

Load bearing capacities of profiles for bending around the y-axis [N]:

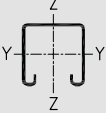
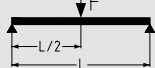
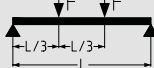
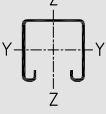
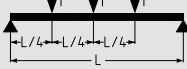
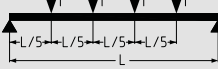
Profile	L [m]						L [m]					
	0.5	1.0	1.5	2.0	4.0	6.0	0.5	1.0	1.5	2.0	4.0	6.0
												
41/21/1.5	895	379	161	83	-	-	667	223	95	48	-	-
41/21/2.0	1,090	440	190	90	-	-	800	260	110	60	-	-
41/41/2.0	3,681	1,833	1,095	601	106	-	2,755	1,376	643	353	62	-
41/41/2.5	4,262	2,122	1,278	701	121	-	3,190	1,593	750	411	71	-
41/62/2.5	8,521	4,248	2,818	2,099	459	117	6,378	3,189	2,114	1,248	270	68
41/42/2.0 H	3,080	1,878	1,157	630	95	-	1,540	1,410	679	370	56	-
41/82/2.0 H	6,563	5,608	3,722	2,774	865	277	3,281	3,281	2,791	2,079	508	162
41/82/2.5 H	11,327	6,617	4,404	3,284	1,021	323	5,663	4,930	3,293	2,459	599	189
41/124/2.5 H	13,646	13,522	8,987	6,711	3,256	1,316	6,823	6,823	6,740	5,031	1,969	772
												
41/21/1.5	445	159	68	35	-	-	370	125	53	27	-	-
41/21/2.0	540	180	80	40	-	-	450	150	60	30	-	-
41/41/2.0	1,841	916	461	253	44	-	1,534	764	362	199	35	-
41/41/2.5	2,131	1,061	538	295	51	-	1,776	884	423	232	40	-
41/62/2.5	4,260	2,124	1,409	896	193	49	3,550	1,770	1,174	703	152	39
41/42/2.0 H	1,027	939	487	265	40	-	770	770	383	208	32	-
41/82/2.0 H	2,188	2,188	1,861	1,387	364	116	1,641	1,641	1,551	1,156	286	91
41/82/2.5 H	3,775	3,286	2,195	1,639	429	136	2,831	2,731	1,827	1,365	337	106
41/124/2.5 H	4,549	4,549	4,493	3,356	1,412	554	3,411	3,411	3,411	2,796	1,109	435

* Please note additional information on the catalog pages of threaded plates/hammer head fasteners.

The determined loads apply for static loads. Calculation based on Eurocode (EC3).

The safety coefficient $\gamma = 1.54$ takes into account the partial and combination coefficients as well as the safety factor of the material.

For the given values, the permissible steel stress and the maximum permissible deflection $L/200$ are not exceeded, taking the deadweight into consideration.

MPR-Support channels

Technical data

Permissible buckling loads for profiles [N]:

Buckling length Lk [mm]	41/21/1.5	41/21/2.0	41/41/2.0	41/41/2.5	41/62/2.5	41/42/2.0 H	41/82/2.0 H	41/82/2.5 H	41/124/2.5 H
200	20,424	29,182	45,557	56,946	75,004	60,984	91,020	110,463	150,007
300	19,270	27,244	44,788	55,811	75,004	59,289	91,010	110,410	150,007
400	17,934	24,922	43,416	54,027	73,330	57,182	89,656	108,751	147,921
500	16,341	22,127	41,962	52,126	71,527	54,901	88,232	107,004	145,627
600	14,508	19,030	40,383	50,048	69,639	52,369	86,698	105,119	143,164
700	12,578	16,008	38,641	47,743	67,631	49,527	85,009	103,040	140,464
800	10,746	13,362	36,711	45,181	65,469	46,359	83,114	100,703	137,446
900	9,139	11,181	34,586	42,366	63,124	42,910	80,954	98,033	134,020
1.000	7,792	9,427	32,296	39,350	60,579	39,301	78,468	94,955	130,091
1.100	6,683	8,024	29,902	36,233	57,831	35,692	75,599	91,401	125,569
1.200	5,774	6,896	27,489	33,134	54,898	32,234	72,317	87,336	120,394
1.300	5,029	5,981	25,140	30,161	51,823	29,033	68,635	82,781	114,570
1.400	4,412	5,232	22,922	27,392	48,668	26,139	64,626	77,839	108,190
1.500	3,899	4,613	20,875	24,864	45,505	23,563	60,419	72,674	101,439
1.600	3,468	4,095	19,015	22,589	42,406	21,289	56,168	67,479	94,553
1.700	3,104	3,659	17,342	20,558	39,428	19,290	52,015	62,423	87,762
1.800	2,793	3,289	15,846	18,752	36,612	17,533	48,063	57,630	81,249
1.900	2,526	2,971	14,512	17,150	33,983	15,989	44,375	53,171	75,131
2.000	2,295	2,697	13,324	15,728	31,550	14,629	40,978	49,074	69,467
2.100	2,094	2,459	12,265	14,464	29,314	13,426	37,877	45,340	64,274
2.200	1,918	2,251	11,319	13,338	27,266	12,361	35,059	41,952	59,541
2.300	1,764	2,068	10,473	12,333	25,395	11,413	32,506	38,885	55,240
2.400	1,627	1,907	9,715	11,433	23,688	10,568	30,194	36,111	51,340
2.500	1,505	1,764	9,033	10,625	22,131	9,811	28,101	33,601	47,802
2.600	1,397	1,636	8,418	9,898	20,711	9,130	26,204	31,328	44,592
2.700	1,300	1,521	7,862	9,240	19,413	8,517	24,483	29,265	41,676
2.800	1,212	1,419	7,358	8,645	18,227	7,963	22,918	27,391	39,022
2.900	1,133	1,326	6,900	8,105	17,141	7,461	21,492	25,685	36,604
3.000	1,062	1,242	6,483	7,613	16,144	7,004	20,192	24,128	34,395
3.100	997	1,166	6,102	7,164	15,229	6,587	19,002	22,705	32,374
3.200	938	1,096	5,753	6,753	14,387	6,206	17,912	21,401	30,522
3.300	884	1,033	5,433	6,376	13,611	5,857	16,911	20,204	28,820
3.400	834	975	5,138	6,029	12,894	5,536	15,990	19,102	27,254
3.500	789	921	4,867	5,710	12,231	5,241	15,141	18,087	25,810
3.600	747	872	4,616	5,415	11,617	4,969	14,357	17,150	24,475
3.700	708	827	4,385	5,142	11,047	4,717	13,631	16,282	23,241
3.800	672	785	4,170	4,889	10,517	4,484	12,959	15,478	22,096
3.900	639	747	3,970	4,655	10,024	4,268	12,334	14,732	21,032
4.000	609	711	3,784	4,436	9,565	4,067	11,753	14,037	20,043
4.100	580	677	3,611	4,233	9,136	3,879	11,212	13,391	19,121
4.200	554	646	3,450	4,043	8,734	3,705	10,707	12,787	18,261
4.300	529	617	3,299	3,866	8,359	3,542	10,235	12,223	17,457
4.400	506	590	3,157	3,700	8,006	3,389	9,794	11,696	16,705
4.500	484	565	3,025	3,544	7,676	3,246	9,380	11,201	16,000
4.600	464	541	2,900	3,398	7,365	3,112	8,992	10,737	15,338
4.700	444	519	2,784	3,261	7,073	2,986	8,627	10,302	14,717
4.800	427	498	2,674	3,132	6,797	2,867	8,284	9,892	14,132
4.900	410	478	2,570	3,011	6,538	2,755	7,961	9,506	13,581
5.000	394	459	2,472	2,896	6,293	2,650	7,656	9,142	13,062
5.100	379	442	2,380	2,788	6,061	2,551	7,368	8,798	12,571
5.200	365	425	2,293	2,686	5,842	2,457	7,097	8,474	12,108
5.300	351	410	2,211	2,589	5,634	2,368	6,840	8,167	11,670
5.400	339	395	2,132	2,497	5,437	2,284	6,596	7,876	11,255
5.500	327	381	2,058	2,410	5,250	2,204	6,366	7,600	10,862
5.600	315	368	1,988	2,328	5,073	2,129	6,147	7,339	10,489
5.700	305	355	1,921	2,250	4,905	2,057	5,939	7,091	10,135
5.800	294	343	1,858	2,175	4,744	1,989	5,742	6,855	9,798
5.900	285	332	1,798	2,105	4,592	1,924	5,554	6,631	9,478
6.000	275	321	1,740	2,037	4,446	1,862	5,375	6,418	9,173



MPR-Support channels

Technical data



Buckling loads as per DIN EN 1993-1-1 sections 6.2 and 6.3.

The values in the table apply for fully bearing cross-sections and central load transmission!

The potentially lower slenderness parameter for buckling and lateral torsional buckling must be examined separately!

Buckling about the z-axis and the y-axis was considered.

The least favourable buckling load is documented in the table.

The safety coefficient $\gamma = 1.54$ takes into account the safety and combination coefficients as well as the safety factor of the material.

Determine the authoritative buckling length L_k depending on the storage conditions and the rod length l , as shown in the figure.

Read off the buckling load F as L_k from the table.

